

INSTRUCTIONS

Rubber Band Boat

You will need: 2 empty butter/spread pot, plastic cup or yoghurt pot, permanent markers, scissors, rubber bands.

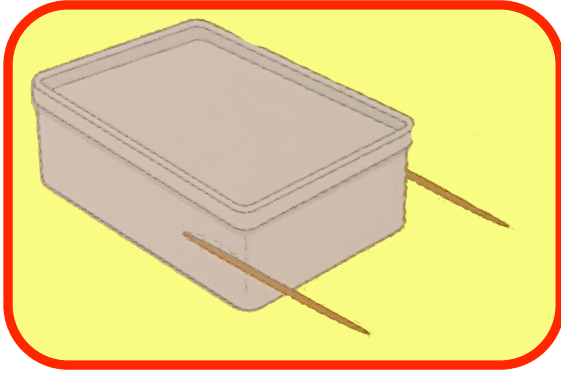

Glue a cocktail stick on both sides of the tub halfway up. They should stick out.

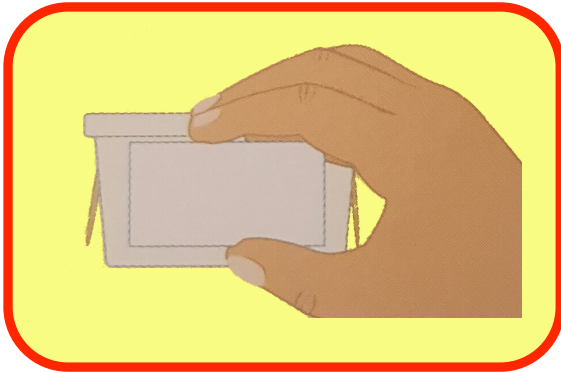

From another tub lid, cut a piece the same shape as the end of the boat but about 1cm smaller all around.

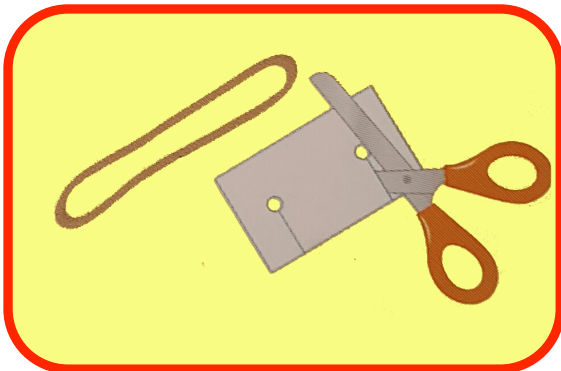

Make 2 holes with a hole-puncher. Cut slits into the holes. Find elastic bands as wide as the end of the boat.

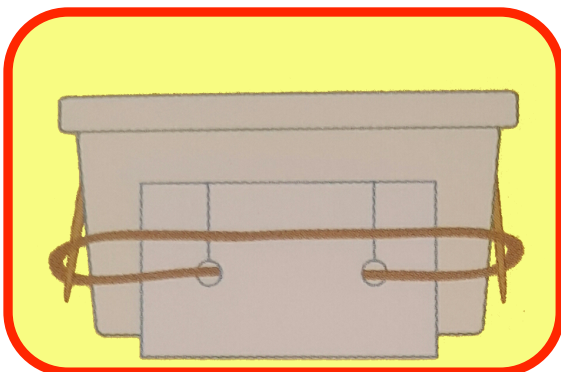

Slip the band through the slits into the holes. Then loop the band over the ends of the sticks.

Rubber Band Boat

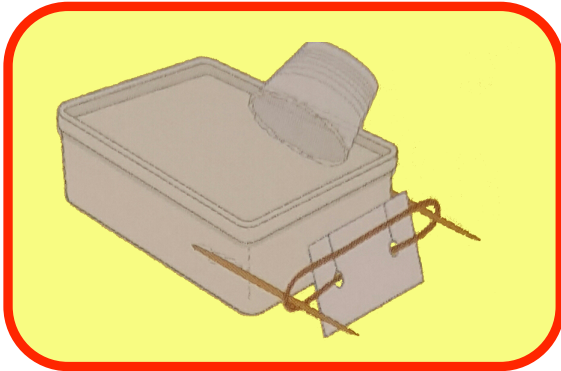

To make the captain's area for your boat, cut a plastic cup in half or use a yoghurt pot that fits on top off the lid and glue it to the lid.

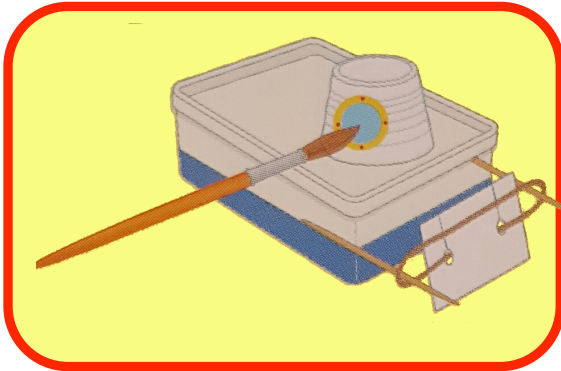

Use permanent markers to decorate your boat. Fill a bath or sink with water for the boat to float in.

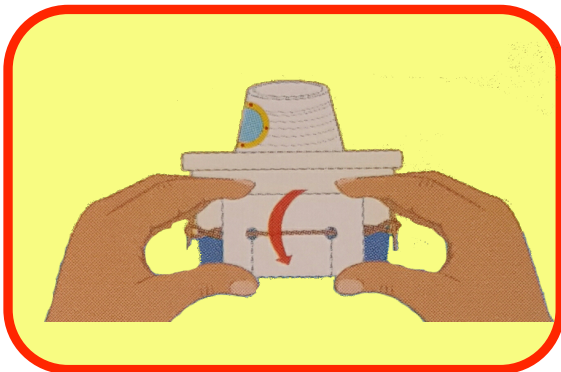

Wind the paddle until the elastic band is wound tightly.



Then let it go! Watch your boat move through the water!